

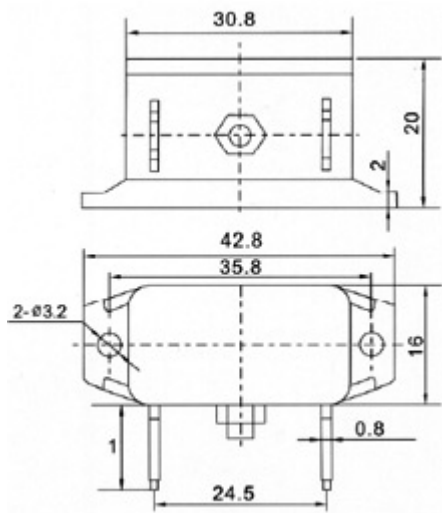

Specification

Model	ST-1012
Rated current	6-15A
Operating voltage	12V-250V

Dimension



Tripping curve

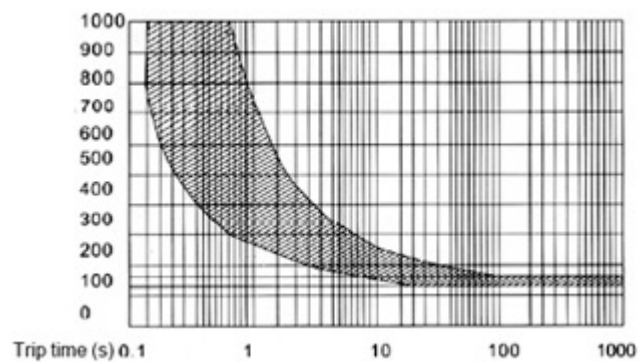

Tripping standards

Overload percentage	Trip time	Overload percentage	Trip time
100%	No trip	500%	0.3-2.8s
150%	In 1 hour	600%	0.25-2s
200%	3.0-12s	800%	0.2-1s
300%	0.8-8s	1000%	0.15-0.8s
400%	0.35-5s		

Environment temperature: 25°C