

## AM3T Series Moulded Case Circuit Breaker

### 1. Application

AM3T moulded case circuit breaker is suitable for circuit AC 50/60Hz, rated voltage up to AC 690V, rated operating current up to 630A. It features normal structure, reliable performance, high breaking capacity, used for power distribution and protecting the circuit and electrical equipment against overload and short circuit. It complies with standard of IEC60947-2.



AM3T-160



AM3T-250

### 2. Specification

Type		AM3T-160	AM3T-250	AM3T-400	AM3T-630
Poles number		3	3	3	3
Rated current In(A)		16~160	100~250	250~400	400~630
Rated operating voltage Ue(V) (AC50/60Hz)		690	690	690	690
Rated insulation voltage Ui(V)		800	800	1000	1000
Rated impulse withstand voltage Uimp(kV)		8	8	8	8
Utilisation category		A	A	A	A
Frequency withstand voltage 1 Minute		3000	3000	3500	3500
Rated limited short-circuit breaking capacity Icu(kA)	220/230V	25	50	70	70
	380/415V	16	36	36	36
	400V	10	25	30	30
	500V	8	20	25	25
	690V	3	5	20	20
Rated operating short-circuit breaking capacity Ics(100%Icu)	220/230V	100%	75%	100%	100%
	380/415V	100%	75%	100%	100%
	400V	100%	75%	100%	100%
	500V	100%	75%	100%	100%
	690V	100%	75%	100%	100%
Rated short-circuit closing capacity Icn(kA)	220/230V	52.5	105	154	154
	380/415V	32	75.6	75.6	75.6
	400V	17	52.5	63	63
	500V	13.6	40	52.5	52.5
	690V	4.3	7.7	40	40
Mechanical life	Operating cycle times	25000	25000	20000	20000
	Operating cycle times per hour	240	240	240	120
Electrical life	Operating cycle times	8000	8000	6000	5000
	Operating cycle times per hour	120	120	120	60

## 3. Outline and Installation Dimension

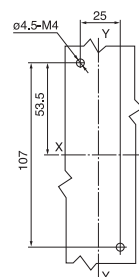
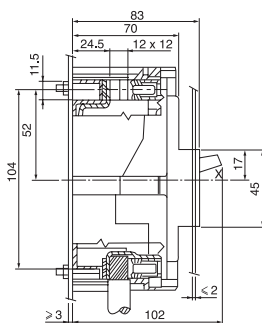
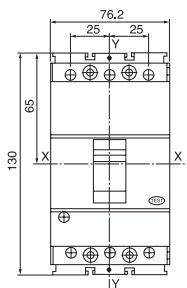

AM3T-160

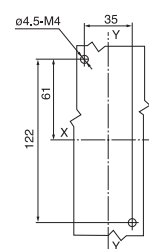
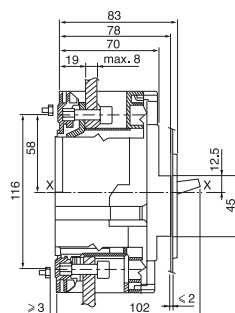
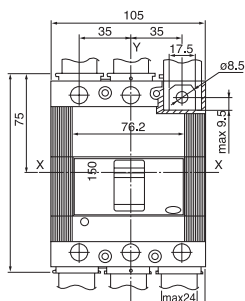

AM3T-250

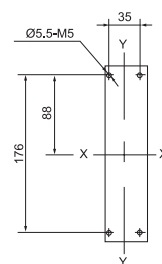
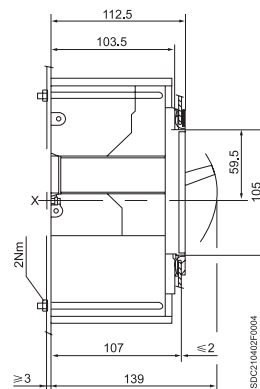
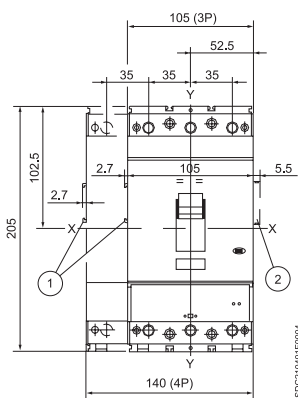

3极

AM3T-400

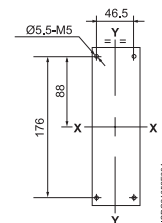
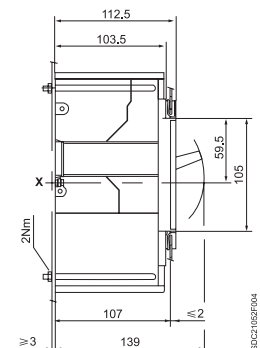
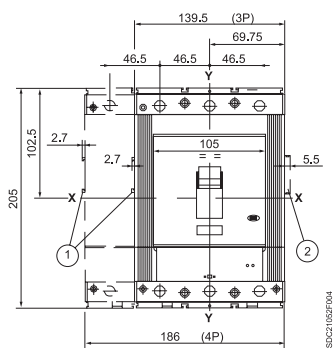

3极

AM3T-630